

Roll Rack Display Systems

The Complete Roll Display Handling System.

Best turns roll handling into a one person operation with EZ-II Displays, roll conveyors and a reversible power winder.

Custom displays are available upon request.

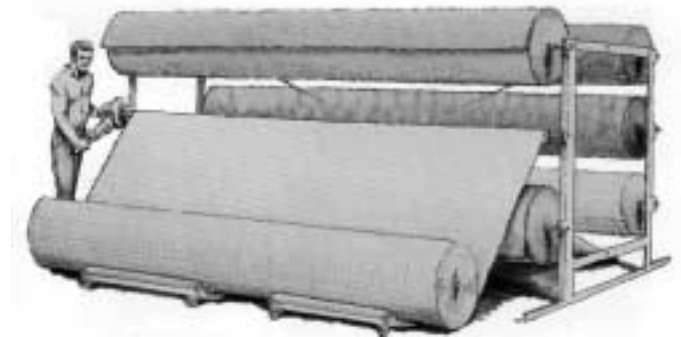

Portable Island Roll Displays



Best's patented EZ-II Roll Display System has been developed from the ground up to give you the edge in today's competitive retail environment. Show, sell and handle your largest rolls in less space, with full access to all goods on display.

Heavy rolls are handled only once during the loading operation, so you reduce the chance of damage and eliminate the repetitive labor involved in shuffling piled inventory.

EZ-II roll brackets can be adjusted to display full rolls, partials, or both. For added security, roll tubes are locked on the rack by a positive system of roll brake and retainer brackets. EZ-II heavy duty welded steel frames and roll tubes insure years of trouble-free service. EZ-II displays are available in island, portable island and wall models, and can be used for both carpeting and vinyl.

Models available:

SDW-610 - 12'

SDW-610 - 6'

Brown powder coated finish

Note: Standard island or wall display packages include core tubes to accommodate the number of 24" diameter carpet rolls illustrated. Core tube assemblies may be purchased separately and added to bring capacity up to the number of partial rolls (12" dia.) shown as smaller circles in these illustrations.

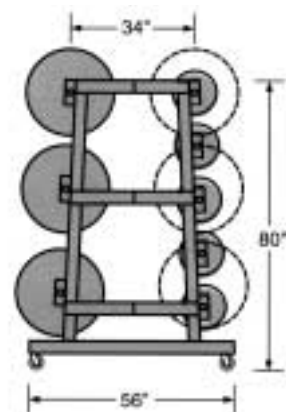

Self Standing, Wall Mounted & Portable Island Displays



Wall Roll Display

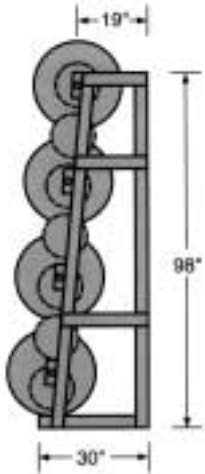

K-47 Wall Display

K Type Wall Displays show 12' or 6' carpet rolls. These display racks are floor supported and can be backed by any wall, regardless of its structure, or used without a wall.

Models available:

K-47 - 12'

K-47 - 6'

Brown powder coated finish



Vinyl Roll Display

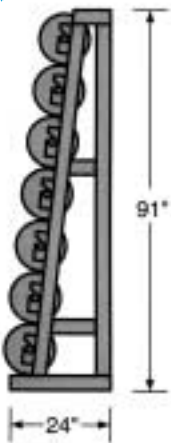

V Type Roll Racks

Best V Type Roll Racks are available for 6' or 12' vinyl rolls. Rack Frames are constructed of welded angle iron and core tubes are heavy duty steel. Core tubes are secured onto the rack by steel retainers for safety, while steel lock pins keep rolls from turning when not loading or unloading.

Models available:

V-7 Portable - 12'

V-7 Portable - 6'

V-7 Stationary - 12'

V-7 Stationary - 6'



Grass and Bath Carpet Roll Displays

Grass and Bath Carpet Racks

For 6' by 24" diameter rolls. Heavy gauge square roll tubes allow easy operation without free rolling. Extra 8' length of roll tubes allow ample grip for lift loading. Durable racks are designed for promotional weight goods.

Rolls capacity - 150 lbs. Black powder coated finish.

GS 230

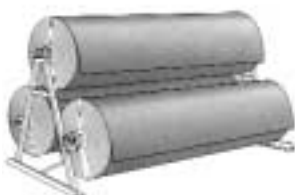

Loaded Height 4' 3". Loaded Depth 4' 2".
Width 8'.

GS 231

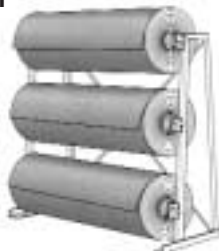

Loaded Height 6' 11". Loaded Depth 2' 6".
Width 8'.

GS 240

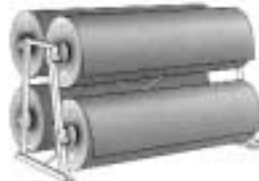

Loaded Height 6' 11". Loaded Depth 5' 0".
Width 8'.

GS 260



Loaded Height 4' 3". Loaded Depth 4' 2".
Width 8'.

Roll Runner Displays



Roll Runner Displays

Single-sided three-roll display
Black powder coated finish

SS 336 - 36" wide
SS 327 - 27" wide

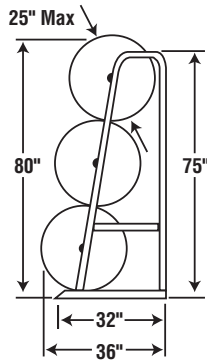

Double-sided six-roll display
Black powder coated finish

DS 636 - 36" wide
DS 627 - 27" wide

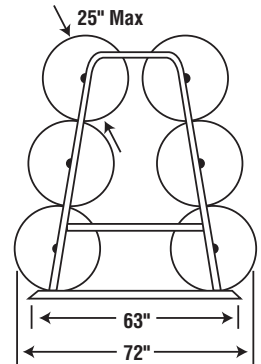

Minimal assembly required.

Roll Remnant Displays



Best RM Remnant Displays

Best RM Remnant Displays allow you to display roll remnants up to 12" in diameter. They are sturdy and space efficient with easy, bolt-together assembly. Available in wall mount and island configurations in a black powder coated finish.

RM-7



Capacity: 7 remnant rolls (12" diameter)
Loaded Height 90". Width 14".
Length 12'.

RM-12

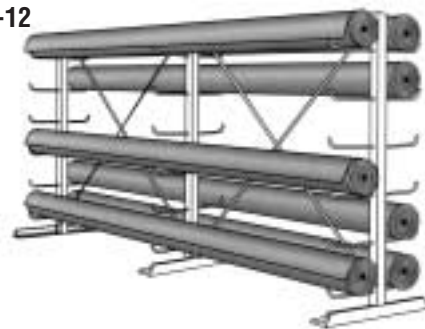

Capacity: 12 remnant rolls (12" diameter)
Loaded Height 78". Width 26".
Length 12'.

Roll Conveyors



Broadloom Carpet Conveyor Model 648

Lets one person handle a roll of carpet. Six tubular steel rollers for smooth handling of large rolls. (Use in pairs is recommended.) Heavy-duty ball bearing caster wheels roll easily, then lock into place to position conveyors for carpet rolls. Available in gray powder coated finish.

25" wide x 51" long x 8 1/2" high.



Roll Conveyors cont.



Vinyl Flooring Dollies

Makes it easy to handle and move vinyl rolls. Maneuverable for transport from storage or loading dock to display areas. (Use in pairs is recommended.) Two sizes available. Gray powder coated finish.

#618 with 3, 18" rollers (12" wide x 22" long x 6" high)

#636 with 3, 36" rollers (12" wide x 44" long x 6" high)

Core Tube Assemblies

Broadloom Core Tube Assemblies

CT151 - 12' Broadloom Core Tube Assembly - 1 tube, 2 carrier brackets (L & R), 1 brake plate, 1 retainer, 1 T-handle, 3 clamps and hardware.

CT78 - 6' Broadloom Core Tube Assembly - Same as 12', except with 2 clamps

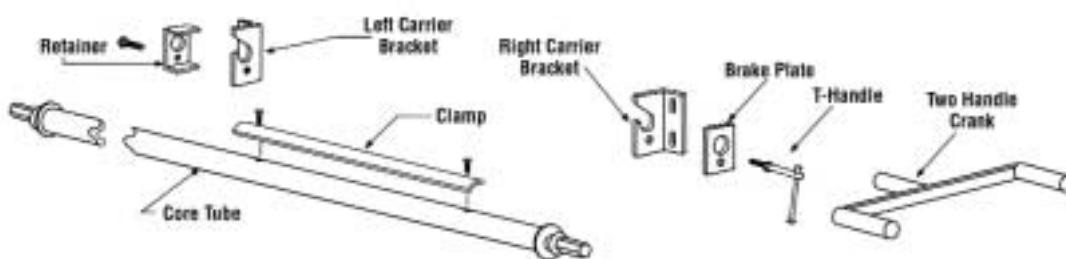

Vinyl Core Tube Assemblies

CT150 - 12' Vinyl Core Tube Assembly - 1 tube, 2 carrier brackets (L & R), 2 retainer flats, 3 clamps, lock bar with chain and hardware.

CT75 - 6' Vinyl Core Tube Assembly - Same as 12', except with 2 clamps

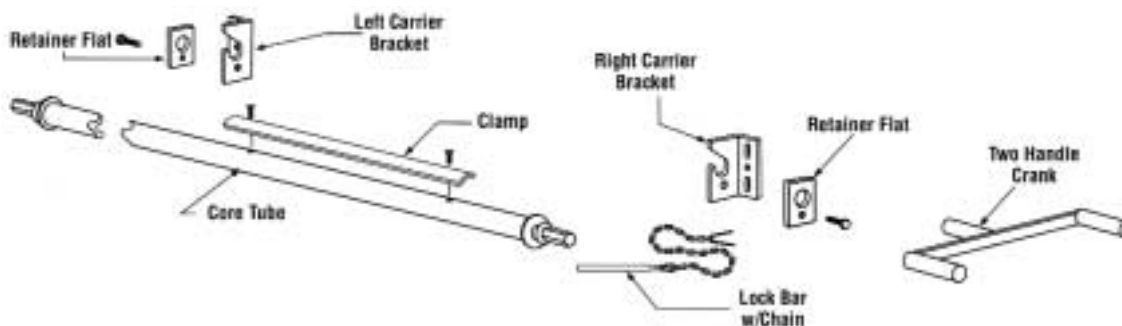

Power Winder

Load your roll displays more quickly with less effort. Saves both time and labor. Includes reversing switch. 110 volt electric service.

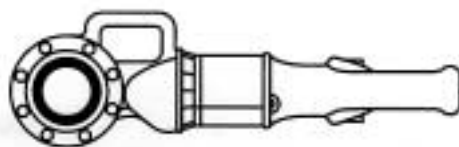



How to Order

Phone Order

Call TOLL FREE 1-800-344-BEST. Sales Representatives are available from 7:30 am to 4:30 pm CST/CDT Monday thru Friday. Please have your catalog handy when placing an order.

FAX: 1-309-932-2127 Available 24 hours.

Pricing

Prices are subject to change without notice. Please have prices quoted when placing your order.

Terms

Net 30 days only to accounts rated 1 or 2 in D&B and with credit approval. No cash discounts allowed. To avoid delay, use your VISA, Mastercard, American Express or mail a check with your order. **NO C.O.D. ORDERS.**

Shipping and Handling

F.O.B., Warehouse or Shipping Point and will be shipped the most economical way, unless instructions are enclosed with order. Shipping and handling charges added to the bottom of order.

Minimum Charge Card Order: \$25.00

\$2.50 handling charge added to orders under \$25.00.

Damaged Goods

UPS Shipment: When merchandise is discovered damaged after opening, call UPS for an inspection report and require UPS to return the item to us. **DO NOT RETURN MERCHANDISE YOURSELF.**

TRUCK Shipment: Note damage on both the driver's copy and your copy. Have the driver sign both copies. You can now file the claim with the carrier. If concealed damages are found, keep the carton and call the carrier for an inspection report. If we can be of any service to help file claims, call our customer service department. **DO NOT REFUSE OR RETURN DAMAGED GOODS TO US.**

Returned Goods

Do not return goods without first receiving permission from us. Returns are subject to a 20% restocking charge. Requests for returns **MUST BE RECEIVED WITHIN 15 DAYS OF DELIVERY.**

Backorders

If item is out of stock, we will Back Order unless requested not to do so.

